

Drawing



Tools for Chefs

Hendi B.V.
Steenoven 21
3911 TX Rhenen
The Netherlands

Batch #

V.01

Appliance part#

264126

Description

Salamander 1/1GN

Date 26-06-2024

Revision # V.01

Revision First Bill of Materials (BOM)

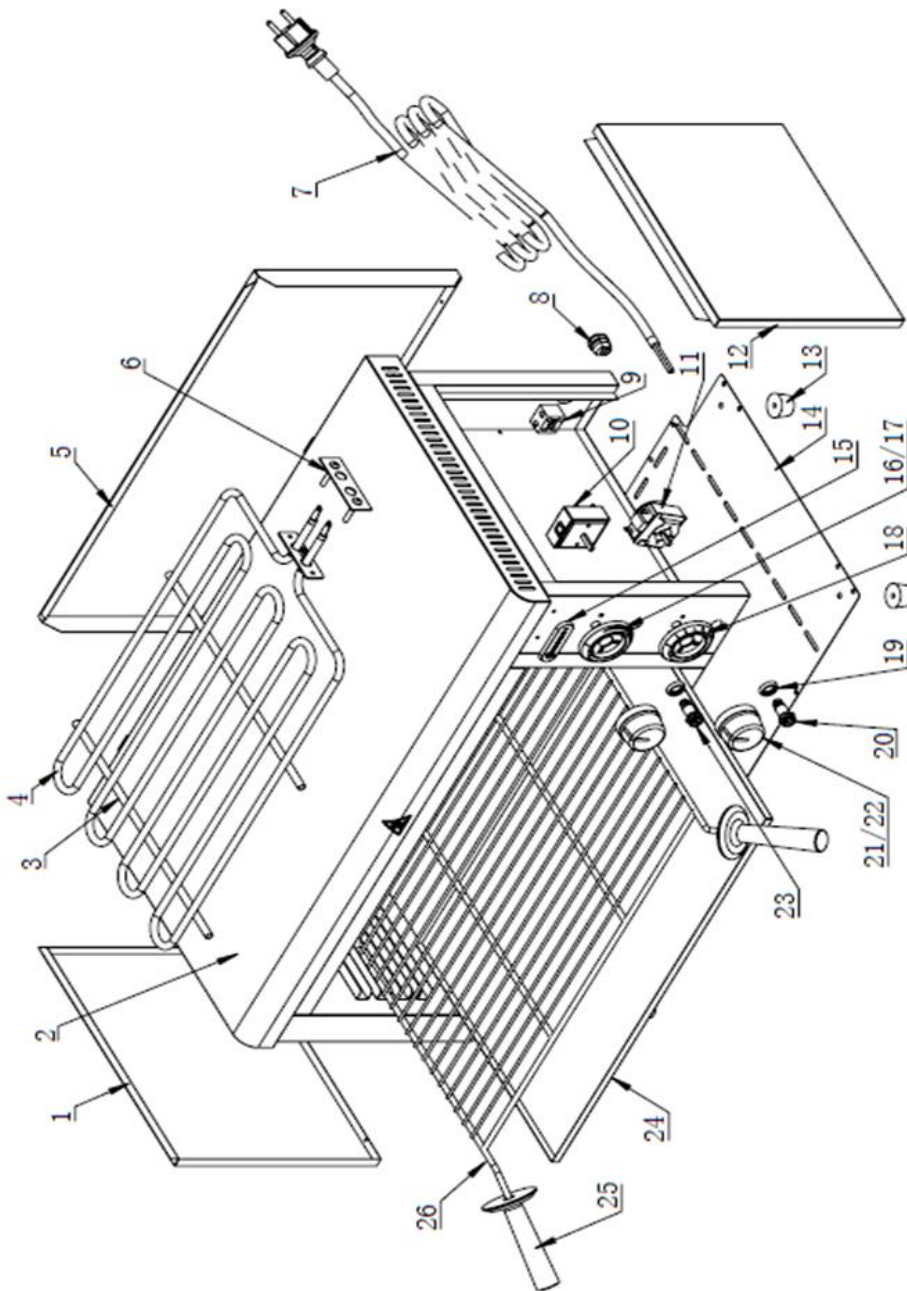

Bill of materials (BOM)

 <b style="font-size: 24px; margin-left: 10px;">HENDI Tools for Chefs Hendi B.V. Steenoven 21 3911 TX Rhenen The Netherlands	Batch #	Appliance part#
	V.01	264126
	Description	
Salamander 1/1GN		

Date	26-06-2024	Revision #	V.01
Revision	First Bill of Materials (BOM)		

Item	Description	Part#	Quantity	Remark	Picture
1	Housing panel (left)	n/a	1		
2	Housing	n/a	1		
3	Heating element support	n/a	2		
4	Heating element	963999	1		
5	Housing panel (back)	n/a	1		
6	Heating element bracket	n/a	1		
7	Power cord	912027	1		
8	Pull relief	912201	1		
9	Terminal	929940	1		
10	Energy regulator	943366	1		
11	Timer (30 minutes)	943359	1		
12	Housing panel (right)	n/a	1		
13	Feet	912058	4	(set of 4pcs)	
14	Housing panel (bottom)	n/a	1		
15	Logo plaque (Hendi)	955963	1		
16	Scale ring (regulator)	nss	1		
17	Knob base plate	nss	2		
18	Scale ring (timer)	nss	1		
*	Timer Knob	943335	1	Incl. item 17, 18, 21 and 22	
*	Regulator knob	943342	1	Incl. item 16, 17, 21 and 22	
19	Silicone ring	nss	2		
20	Indicator light (green)	942925	1	Incl. item 19	
21	Knob	nss	2		
22	Knob insert	nss	2		
23	Indicator light (orange)	912003	1		
24	Crumb tray	n/a	1		
25	Grid handle	964002	2		
26	Grid	964019	1		

n/a -> not available

nss -> not sold separately

Circuit diagram

 HENDI Tools for Chefs Hendi B.V. Steenoven 21 3911 TX Rhenen The Netherlands	Batch #	Appliance part#
	V.01	264126
	Description	
	Salamander 1/1GN	

Date	26-06-2024	Revision #	V.01
Revision	First Bill of Materials (BOM)		

