

## Wall-mounted extractor hood

229316

Made of durable stainless steel (AISI 430). Equipped with a set of stainless steel labyrinth filters which can be washed in dishwashers. With collection pan for catching fat and grime that comes from the filters. Fitted with an  $\varnothing 200$  mm ventilation connection at the top. The hood isn't equipped with a fan, this needs to be done separately.

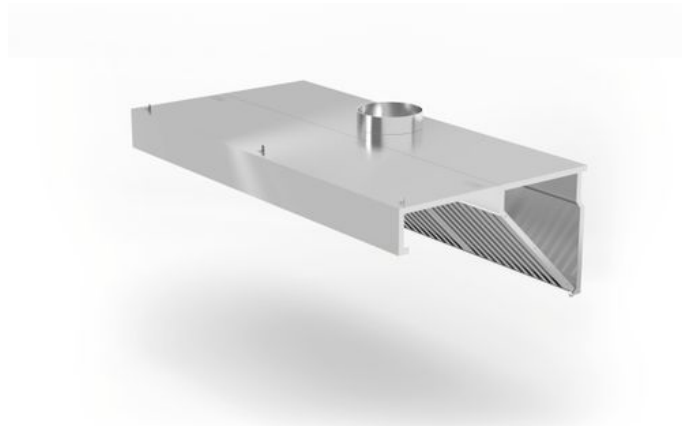

### Specifications

Materials	: Stainless steel
Packed per	: 1
Length (mm)	: 1200
Width (mm)	: 700
Height (mm)	: 450
Measurements	: 1200x700x(H)450

### Transport specifications

EAN	: 8711369229316
Intrastat code	: 0
Gross weight (kg)	: 27.65
Net weight (kg)	: 27.59
Sales units per pallet	: 4
Plastic packaging (gram)	: 60

#### HENDI B.V.

Innovatielaan 6  
6745 XW De Klomp, The Netherlands  
T: +31 (0)317 681 040  
E: info@hendi.eu

#### HENDI Polska Sp. z o.o.

ul. Firmowa 12  
62-023 Robakowo, Poland  
T: +48 61 6587000  
E: info@hendi.pl

#### HENDI GmbH

Ehring 15  
5112 Lamprechtshausen, Austria  
T: +43 (0) 6274 200 10 0  
E: office.austria@hendi.eu

#### HENDI S.R.L.

Str. 13 decembrie 94A, Hala 14  
Braşov, 500164, Romania  
T: +40 268 320330  
E: office@hendi.ro

#### PKS HENDI South East Europe SA

5 Metsovou Str.  
18346 Moschato, Athens, Greece  
T: +30 210 4839700  
E: info@pks-hendi.com

#### HENDI Italia S.R.L.

Via Leonardo da Vinci 4  
39100 Bolzano (BZ), Italy  
T: 800 727 438  
E: office.italy@hendi.eu