

Drawing



Hendi B.V.
 Steenoven 21
 3911 TX Rhenen
 The Netherlands

Batch #	Appliance part#
000000 and up (until 12-2017)	232194
Description	
Blast Chiller 7 X GN 1/1	

Date	29-10-2020	Revision #	1.0
Revision	First Bill of Materials (BOM)		

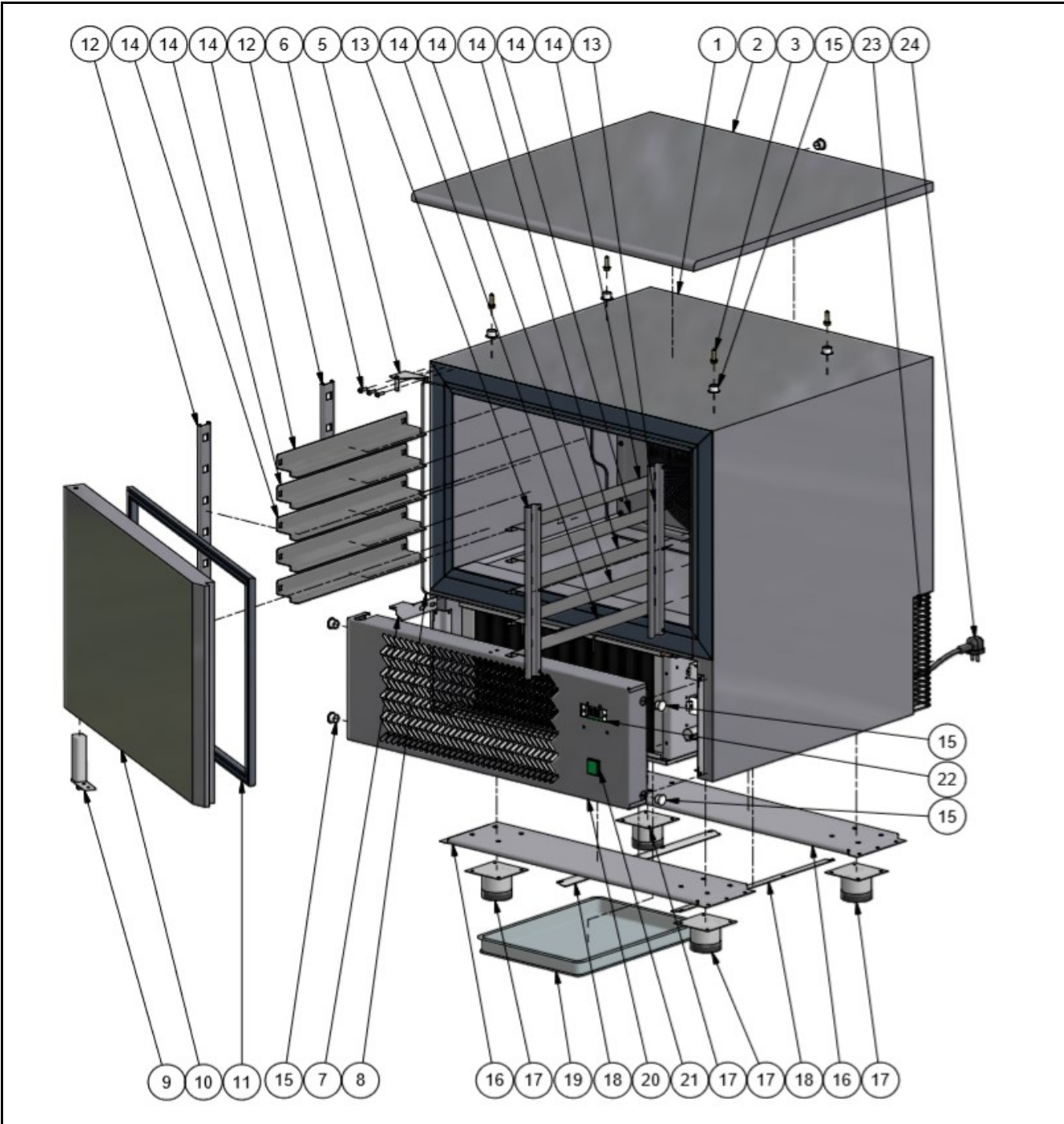

Bill of materials (BOM)

 <b style="font-size: 24px; margin-left: 10px;">HENDI <small style="color: green; margin-left: 10px;">Tools for Chefs</small> Hendi B.V. Steenoven 21 3911 TX Rhenen The Netherlands	Batch #	Appliance part#
	000000 and up (until 12-2017)	232194
	Description	
Blast Chiller 7 X GN 1/1		

Date	29-10-2020	Revision #	1.0
Revision	First Bill of Materials (BOM)		

Item	Description	Part#	Quantity	Remark	Picture
1	Housing	n/a	1		
2	Housing Cover	n/a	1		
3	Screw for Housing Cover	n/a	1		
5	Upper Hinge	n/a	1		
6	Screw for Upper Hinge	n/a	1		
7	Lower Hinge Holder	n/a	1		
8	Magnetic Seal	n/a	1		
9	Torsion Hinge	n/a	1		
10	Door	n/a	1		
11	Door Gasket	948538	1		
12	Shelf Guide Holder (Left)	n/a	2		
13	Shelf Guide Holder (Right)	n/a	2		
13A	Shelf Guide Holder Set (L+R)	n/a	1		
14	Shelf Holder	943526	14		
15	Screw cover	n/a	9		
16	Bottom Plate	n/a	2		
17	Foot	n/a	4		
18	Collection Tray Holder	n/a	2		
19	Collection Tray	n/a	1		
20	Front Panel	n/a	1		
21	Switch	n/a	1		
22	Main PCB	943533	1		
23	Protective Grid	n/a	1		
24	Power Cord	n/a	1		
	Display Sticker (Hendi)	943571	1	Not shown on Drawing	

n/a -> not available

nss -> not sold separately

Drawing



Hendi B.V.
Steenoven 21
3911 TX Rhenen
The Netherlands

Batch #	Appliance part#
000000 and up (until 12-2017)	232194
Description	
Blast Chiller 7 X GN 1/1	

Date	29-10-2020	Revision #	1.0
Revision	First Bill of Materials (BOM)		

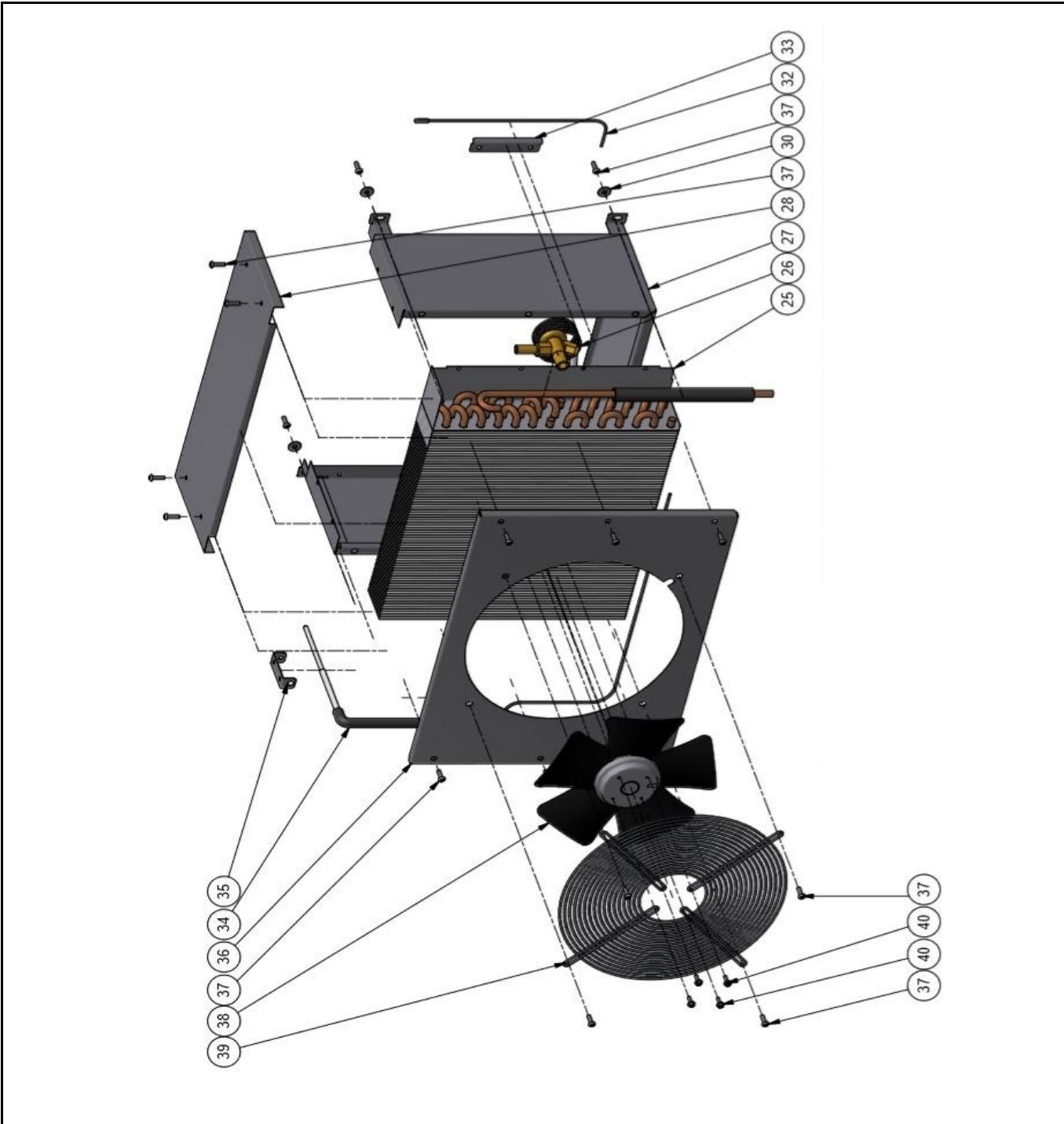

Bill of materials (BOM)

 Hendi B.V. Steenoven 21 3911 TX Rhenen The Netherlands	Batch #	Appliance part#
	000000 and up (until 12-2017)	232194
	Description	
Blast Chiller 7 X GN 1/1		

Date	29-10-2020	Revision #	1.0
Revision	First Bill of Materials (BOM)		

Item	Description	Part#	Quantity	Remark	Picture
25	Evaporator (Cold Side)	n/a	2		
26	Thermostatic Valve	n/a	2		
27	Evaporator Housing	n/a	2		
28	Cover Evaporator Housing	n/a	2		
30	Washer	n/a	8		
32	Chamber Probe (PTC)	943540	1		
33	Chamber Probe Cover	n/a	1		
34	Core Temperature Probe	943557	1		
35	Core Temperature Probe Bracket	n/a	1		
36	Front Cover Evaporator	n/a	2		
37	Screw (stainless Steel)	n/a	28		
38	Fan	928912	2		
39	Fan Grill	n/a	2		
40	Fan Mounting Screw	n/a	8		

n/a -> not available

nss -> not sold separately

Drawing



Tools for Chefs

Hendi B.V.
 Steenoven 21
 3911 TX Rhenen
 The Netherlands

Batch #	Appliance part#
000000 and up (until 12-2017)	232194
Description	
Blast Chiller 7 X GN 1/1	

Date	29-10-2020	Revision #	1.0
Revision	First Bill of Materials (BOM)		

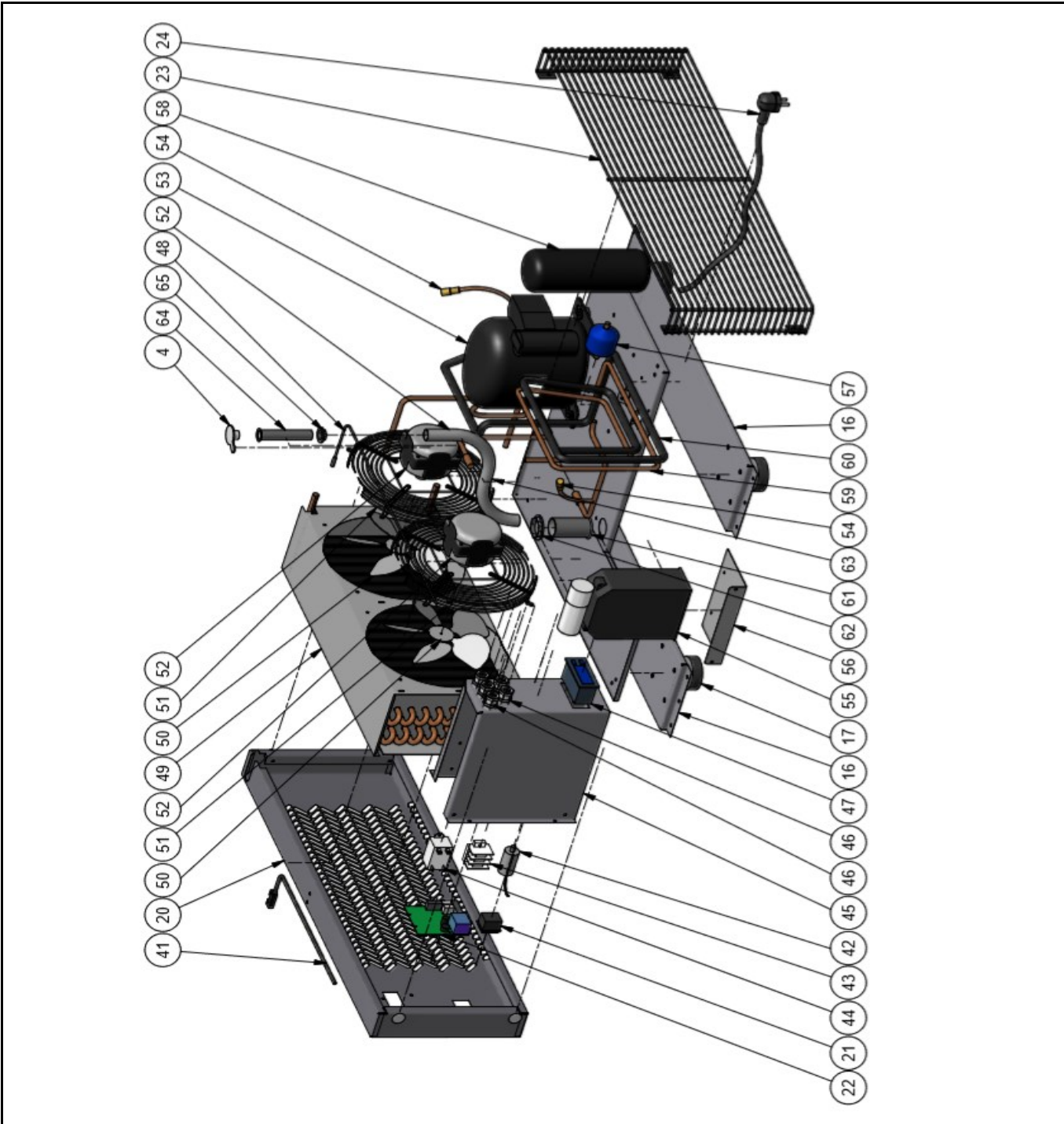

Bill of materials (BOM)

 HENDI <small>Tools for Chefs</small> Hendi B.V. Steenoven 21 3911 TX Rhenen The Netherlands	Batch #	Appliance part#
	000000 and up (until 12-2017)	232194
	Description	
Blast Chiller 7 X GN 1/1		

Date	29-10-2020	Revision #	1.0
Revision	First Bill of Materials (BOM)		

Item	Description	Part#	Quantity	Remark	Picture
4	Bottom Drain Plug	n/a	1		
16	Bottom Plate	n/a	2		
17	Foot	n/a	4		
20	Front Panel	n/a	1		
21	Switch	n/a	1		
22	Main PCB	943533	1		
23	Protective Grid	n/a	1		
24	Power Cord	n/a	1		
41	Door Sensor	n/a	1		
42	Capacitor 1.5µF	n/a	1		
43	Terminal	n/a	2		
44	Relay Finder 66.82.8.230.0300	n/a	1		
45	Inner Housing	n/a	1		
46	Cable Retention	n/a	5		
47	Fan Controller (condensor)	n/a	1	EW961	
48	Temperature Sensor Fan Controller	n/a	1	(NTC)	
49	Condensor	n/a	1		
50	Fan Blade	n/a	2		
51	Fan Grill (230mm)	n/a	2		
52	Fan	951811	2		
53	Compressor	n/a	1		
54	Compressor Fill Valve	n/a	2		
55	Electrical Box Compressor	n/a	1		
56	Electrical Box Bracket	n/a	1		
57	Solid Cartridge Filter	n/a	1		
58	Liquid Separator	n/a	1		
59	Coolant Pipe A	n/a	1		
60	Coolant Pipe B	n/a	1		
61	Drain Ø32mm	n/a	1		
62	Ring for Drain Ø32mm	n/a	1		
63	PVC Drain Tube Ø20mm	n/a	1		
64	PVC Drain Pipe Ø20mm	n/a	1		
65	Ring for Drain Pipe Ø20mm	n/a	1		

n/a -> not available

nss -> not sold separately

Drawing

 HENDI Tools for Chefs Hendi B.V. Steenoven 21 3911 TX Rhenen The Netherlands	Batch #	Appliance part#
	000000 and up (until 12-2017)	232194
	Description	
	Blast Chiller 7 X GN 1/1	

Date	29-10-2020	Revision #	1.0
Revision	First Bill of Materials (BOM)		



Bill of materials (BOM)

 HENDI <small>Tools for Chefs</small> Hendi B.V. Steenoven 21 3911 TX Rhenen The Netherlands	Batch #	Appliance part#
	000000 and up (until 12-2017)	232194
	Description	
Blast Chiller 7 X GN 1/1		

Date	29-10-2020	Revision #	1.0
Revision	First Bill of Materials (BOM)		

Item	Description	Part#	Quantity	Remark	Picture
66	Gris GN 1/1 Blast Chiller	943564	1		
67	Perforated Plate	n/a	1		
67A	Perforated Plate Stainless Steel	n/a	1		
68	Perforated Shelf 60X40cm	n/a	1		
68A	Perforated Shelf Stainless Steel 60X40cm	n/a	1		
69	GN 1/1 Stainless Steel Pan	n/a	1		
69A	Stainless Steel Pan 60X40cm	n/a	1		
70	GN 1/1 Stainless Steel Pan 150	n/a	1		
71	Lid GN 1/1 Stainless Steel	n/a	1		
72	PP Tray witg Fasje Bottom	n/a	1		
	Wheel Set	n/a	4	Not shown on Drawing(s)	

n/a -> not available

nss -> not sold separately