

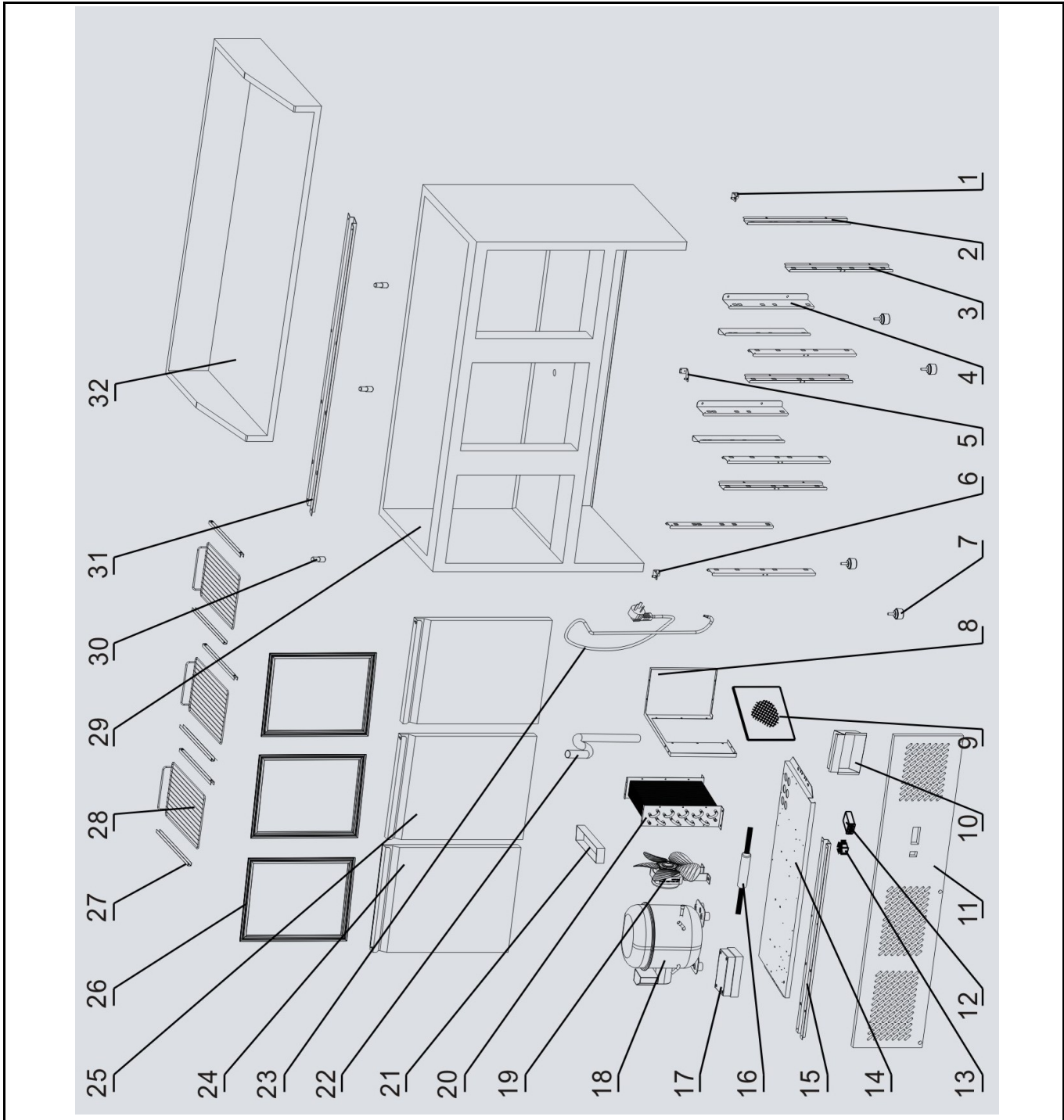

Drawing

 HENDI FOOD SERVICE EQUIPMENT Hendi B.V. Steenoven 21 3911 TX Rhenen The Netherlands	Batch #	Appliance part#
	660525 until 192318	232033
	Description	
	Pizza counter with three doors	

Date	21-06-2021	Revision #	1.0
Revision	First bill of materials (BOM)		



Bill of materials (BOM)

 HENDI FOOD SERVICE EQUIPMENT Hendi B.V. Steenoven 21 3911 TX Rhenen The Netherlands	Batch #	Appliance part#
	660525 until 192318	232033
	Description	
Pizza counter with three doors		

Date	21-06-2021	Revision #	1.0
Revision	First bill of materials (BOM)		

Item	Description	Part#	Quantity	Remark	Picture
1	Bottom hinge (right)	931738	1		
2	Right holder	n/a	2		
3	Front holder	n/a	6		
4	Rear middle holder	n/a	4		
5	Bottom middle hinge	n/a	1		
6	Bottom hinge (left)	931745	1		
7	Feet	931523	4		
8	Air duct board	n/a	1		
9	Condenser filter	931752	1		
10	Electric box cover	n/a	1		
11	Front panel	931769	1		
12	Digital controller Carel (Cooling)	931530	1		
13	Switch	931547	1		
14	Bottom cover	n/a	1		
15	Bracket	n/a	1		
16	Drying filter	n/a	1		
17	Junction box	n/a	1		
18	Compressor Embraco (EMT65HLR)	941515	1		
19	Fan motor 30W	931776	1		
20	Condenser	941522	1		
21	Drain pan	n/a	1		
22	Drain pipe	n/a	1		
23	Power cord	931554	1		
24	Left door	931790	1		
25	Right door	931806	2		
26	Door seal	931813	3		
27	Shelf holder set of 2 pcs (57cm)	931820	6		
28	Shelf (57x33cm)	931561	3		
29	Frame	n/a	1		
30	Upper axis	931837	3		
31	Bracket	n/a	1		
32	Marble top cover	n/a	1		

n/a -> not available

nss -> not sold separately

Circuit diagram

 <b style="font-size: 2em; color: red;">HENDI FOOD SERVICE EQUIPMENT Hendi B.V. Steenoven 21 3911 TX Rhenen The Netherlands	Batch #	Appliance part#
	660525 until 192318	232033
	Description	
	Pizza counter with three doors	

Date	21-06-2021	Revision #	1.0
Revision	First bill of materials (BOM)		

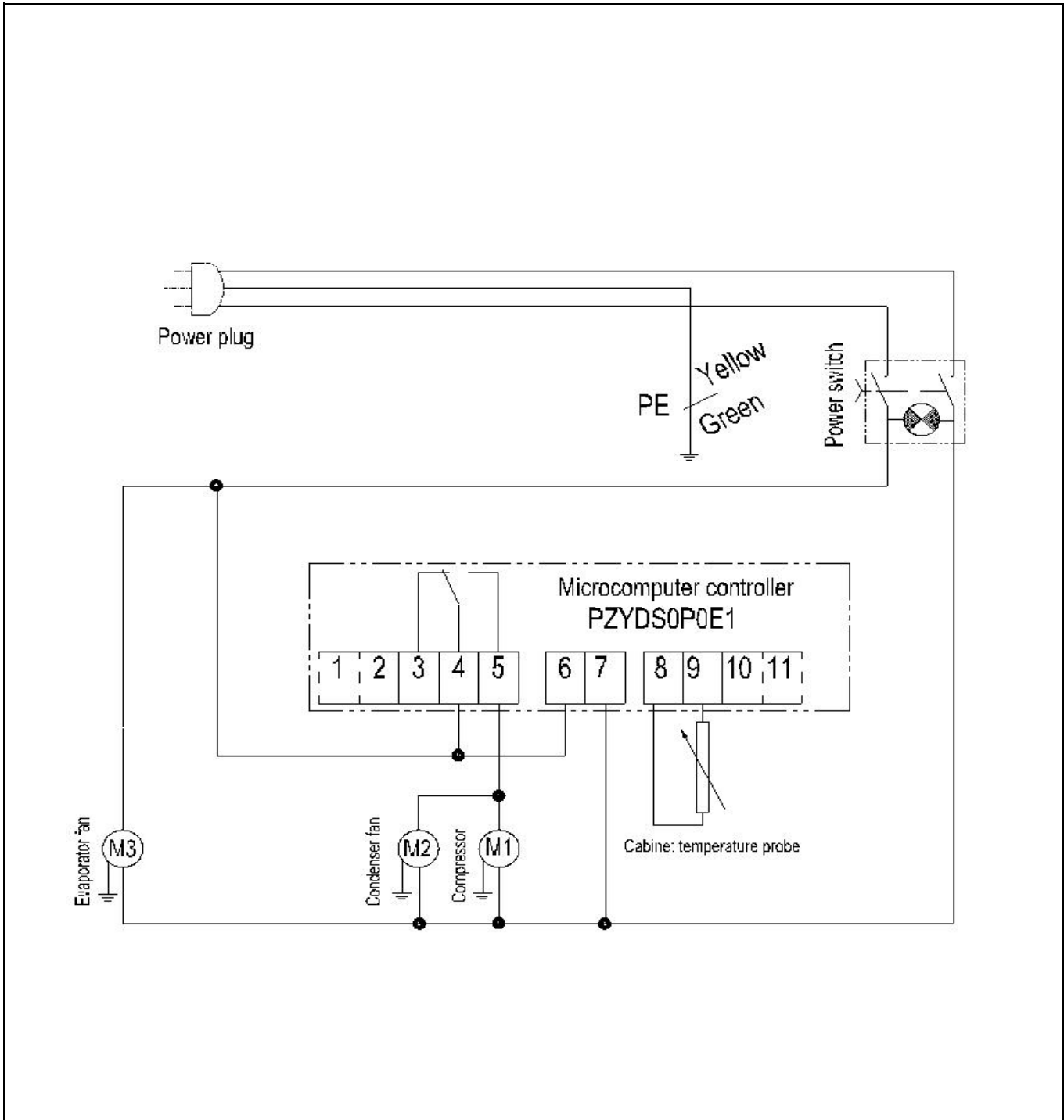

Drawing

 HENDI FOOD SERVICE EQUIPMENT Hendi B.V. Steenoven 21 3911 TX Rhenen The Netherlands	Batch #	Appliance part#
	660525 and up	232033
	Description	
	Pizza counter with three doors	

Date	21-06-2021	Revision #	1.0
Revision	First bill of materials (BOM)		

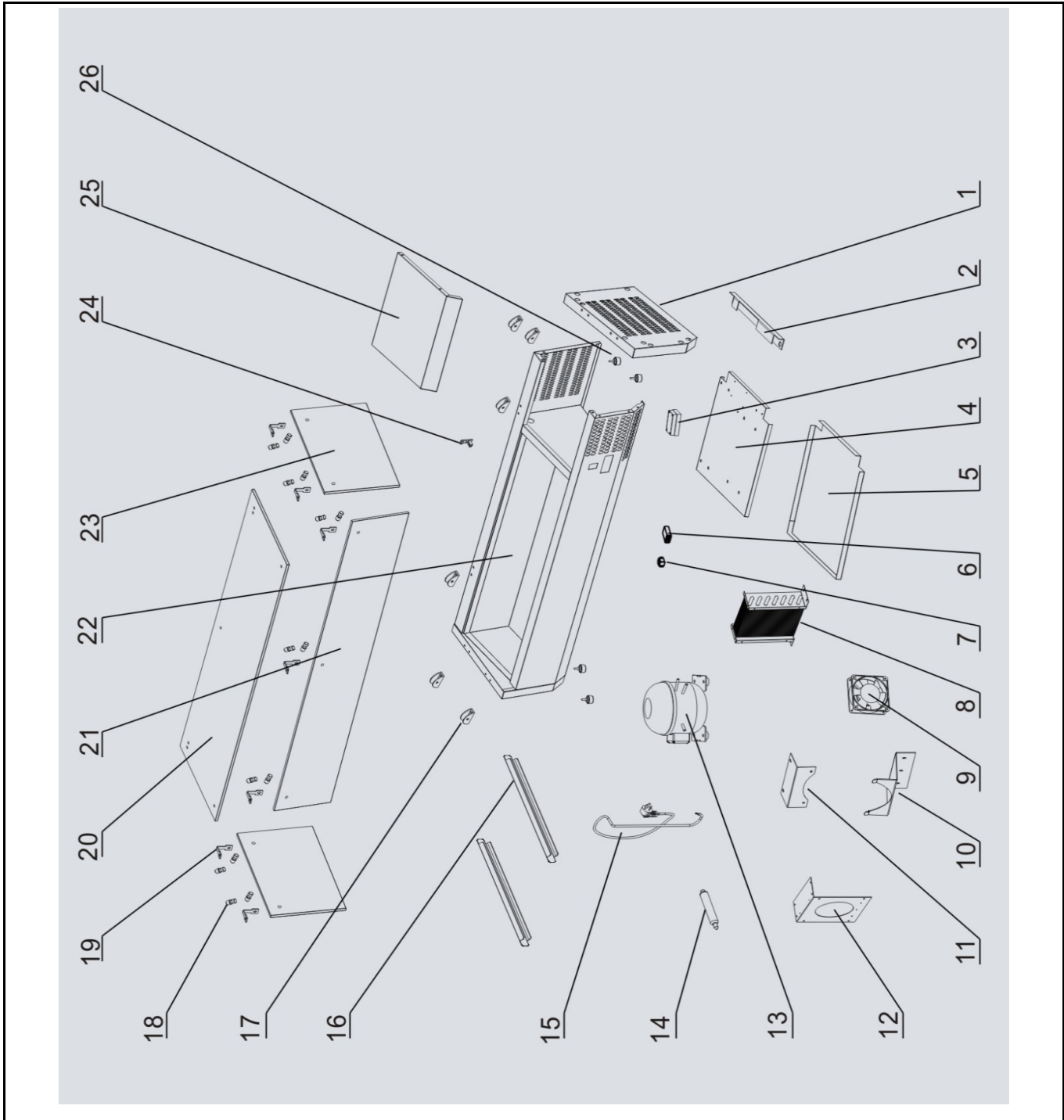

Bill of materials (BOM)

 <b style="font-size: 24px; font-weight: bold;">HENDI <small>FOOD SERVICE EQUIPMENT</small> Hendi B.V. Steenoven 21 3911 TX Rhenen The Netherlands	Batch #	Appliance part#
	660525 until 192318	232033
	Description	
Pizza counter with three doors		

Date	21-06-2021	Revision #	1.0
Revision	First bill of materials (BOM)		

Item	Description	Part#	Quantity	Remark	Picture
1	Side cover	n/a	1		
2	Bracket side cover	n/a	1		
3	Junction Box	n/a	1		
4	Bracket	n/a	1		
5	Bottom cover	n/a	1		
6	Digital controller Dixell (Cooling)	931608	1	Model XR02CX	
7	Switch	205426	1		
8	Condenser	n/a	1		
9	Fan	931875	1		
10	Lower bracket fan	n/a	1		
11	Upper bracket fan	n/a	1		
12	Air duct	n/a	1		
13	Compressor	n/a	1		
14	Drying filter	n/a	1		
15	Power cord	931554	1		
16	Adaptor bar 270x75mm	931622	4		
17	Fixture glass	931639	6		
18	Bolt and nut	nss	14	Available as 931646	
19	Angle bracket	931646	7	Sold per pcs, Incl item 18	
20	Upper glass plate	941669	1	1393x330x8mm	
21	Back glass plate	941676	1	1370x195x8mm	
22	Frame	n/a	1		
23	Left / right glass plate	931677	2	330x195x8mm	
24	Holder probe	n/a	1		
25	Upper cover	n/a	1		
26	Feet	931523	4		

n/a -> not available

nss -> not sold separately

Circuit diagram

 <p>Hendi B.V. Steenoven 21 3911 TX Rhenen The Netherlands</p>	Batch #	Appliance part#
	660525 until 192318	232033
	Description	
	Pizza counter with three doors	

Date	21-06-2021	Revision #	1.0
Revision	First bill of materials (BOM)		

